INSTRUCTIONS FOR INSTALLATION AND USE

Ceiling Fan Model Loft (FN511XX)

BEFORE YOU START

Proper use:

- This product is intended exclusively for non-commercial use as ceiling fan.
- The product has to be installed and used in accordance with these instructions.
- Any use of this product that is not in accordance with these instructions will void the legal warranty of the manufacturer.

Please keep the original carton and packaging material as the warranty will only be honored if product is returned in complete original packaging.

FOR YOUR OWN SAFETY

General safety instructions:

- For the safe use of this product, you need to have read and understood these instructions before installing or using the product.
- Please follow all safety instructions! If you ignore these safety instructions, you will endanger yourself and others.
- Keep these instructions for future reference.
- All parts of this product have to be installed properly in order to ensure safe operation.
- Modification of the product and use of non-approved parts are prohibited.
- This product is not intended for use by persons (including children) with reduced physical, sensory or mental capabilities, or lack of experience and knowledge, unless they have been given supervision or instruction concerning the use of the product by a person responsible for their safety. Children should be supervised to ensure that they do not play with the product.

Electrical safety:

- The electrical installation must be performed by a qualified electrician and must be in accordance with national and local regulations.
- Use a fault-current circuit breaker with a rated residual current of no more than 30 mA.
- Make sure to install an all-pole disconnection switch having a contact separation of at least 3mm between poles in the supply wiring to the ceiling fan.
- Before connecting the appliance to the electrical grid, make sure that it will only be operated within the specified parameters.
- The fan must be properly grounded to avoid the risk of electric shocks.
- Switch off the power before connecting, repairing or cleaning the fan.
- Install only bulbs of the type intended for your fan.

Storage and transport::

- Always store the fan in a dry environment.
- Protect the fan from damages during transport.

Safety instructions specific to this fan:

- Attach the fan only directly to the ceiling structure.
- The carrying capacity of the ceiling structure from which the fan is hung must be at least 100kg.
- The minimum distance between the blades of the fan and the floor must be 2.3m.
- Never mount the fan outside or in a humid or wet environment. The fan can not be installed within proximity of water (e.g. bath tub, swimming pool, water connection).
- The fan can only be installed horizontally on the ceiling.
- Install only bulbs of the type intended for your fan.
- Switch off the power before connecting, repairing or cleaning the fan.
- The rotor area has to be kept clear of any objects at all times.
- Be careful when working near the rotating blades.

FAN OVERVIEW

1. Motor housing
2. Fan blades
3. Canopy
4. Fan light housing
5. Glass shade
6. Switch for rotating direction

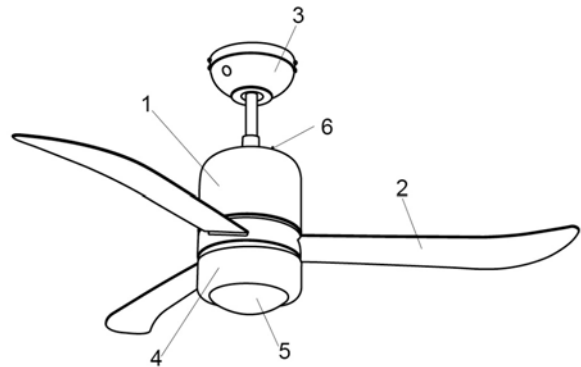

UNPACK THE FAN

- Unpack the fan and check that contents of are complete.
- Dispose of packaging – see also “Disposal”.

Contents of packaging:

Instructions for installation and use	Canopy
Mounting bracket	Screws
Motor housing	Spring washers
Fan blades	Flat washers
Fan light housing	Transmitter for remote control
Glass shade	Receiver for remote control

Note: In case of damaged or missing parts, please contact your retailer.

INSTALLATION

Risk of electric shock: Switch off the electricity using the switch at the circuit breaker box before installing the fan.
Risk of electric shock: The electrical installation must be performed by a qualified electrician and must be in accordance with national and local regulations.
Risk of injury: In case you need to drill holes for mounting the fan, make sure that the drills have sufficient distance to in-ceiling wiring.

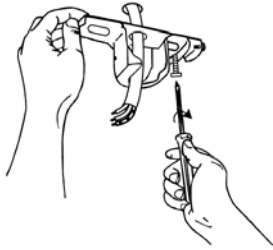

1. Pass the supply wires through the hole in the mounting bracket. Secure the mounting bracket to a ceiling joist or other structural ceiling element with two screws, spring washers and flat washers. Ensure that the support for the mounting bracket is capable of safely holding the moving weight of the fan.

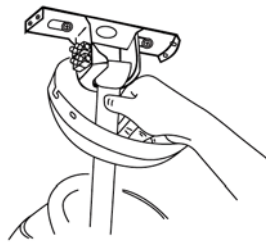

2. Hang the fan assembly with the ball joint onto the mounting bracket. Make sure the guide pin of the bracket is fitted into the corresponding slot of the ball joint. You should feel the guide pin setting into the slot of the ball joint.

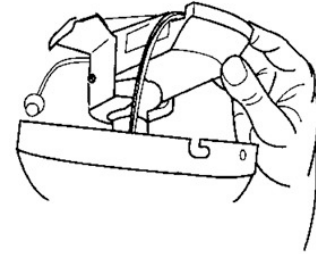

3. Install the remote control receiver in the bracket as shown. Make sure that you do not trap any wires.

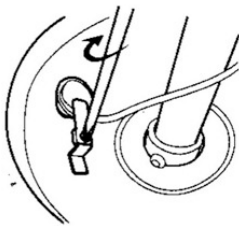

4. Loosen the screw in the sensor bracket and insert the infra-red sensor into the hole in the canopy. Ensure that the infra-red sensor is held by the metal plate as shown and tighten the screw.

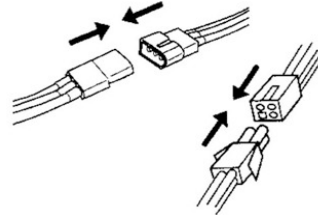

5. Connect the pair of 3-way connectors from the bracket to the remote control receiver. Then, connect the pair of 4-way connectors from the remote control receiver to the fan.

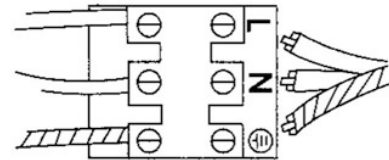

6. Connect wires from supply and bracket to the wiring terminals as follows:
Brown wire - "L"
Blue wire - "N"
Green/yellow striped wire - "⏏"

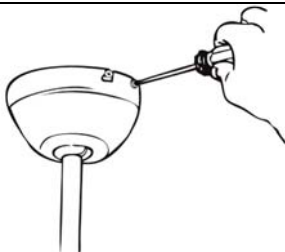

7. Slide the slots on the canopy onto the screws at either end of the mounting bracket and secure the canopy with the four screws, spring washers and star washers provided.

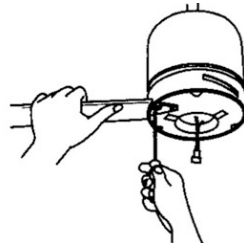

8. Unscrew the screws and spring washers from the fan motor. Install the fan blades onto the motor by tightening the screws and spring washers evenly.

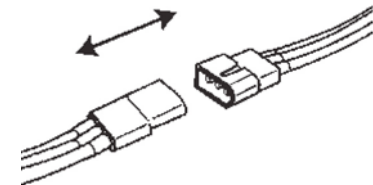

9. Connect the fan light by clipping together the two plastic connectors as shown.

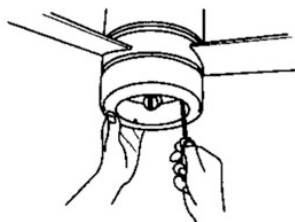

10. Attach the fan light housing to the mounting plate on the fan housing by using the three fixing screws and star washers. Ensure that you do not trap any wires.

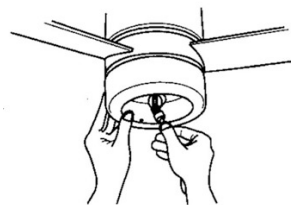

11. Install a proper lamp to the socket (G9 Halogen, max. 40W, not included).

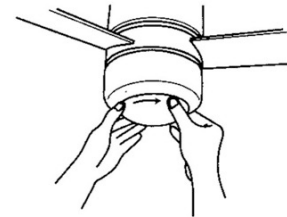

12. Install the glass shade onto the fan light housing by carefully rotating the lampshade clockwise.

OPERATING THE FAN

Check the fan before switching it on!

Risk of injury: The fan can only be operated if no defects have been found upon inspection. In case a part is defective, it will have to be replaced before using the fan.

Risk of injury: Before changing the fan rotating direction, the fan has to be switched off and come to a complete stop.

Check that the fan is in safe operating condition:

- Check to make sure that there are no visible defects.
- Verify that all parts are properly installed and fastened.

Remote control

Install two AAA batteries to the transmitter (batteries not included with transmitter).

- Press the "ON / OFF" button to turn the light on or off.
- For using the dimmer function, press and hold the "DIMMER" button to adjust the intensity of the light.
- Press one of the fan speed buttons to control the speed of the fan:
 - o HI: High speed
 - o MED: Medium speed
 - o LOW: Low speed
- Press the OFF button to turn off the fan.

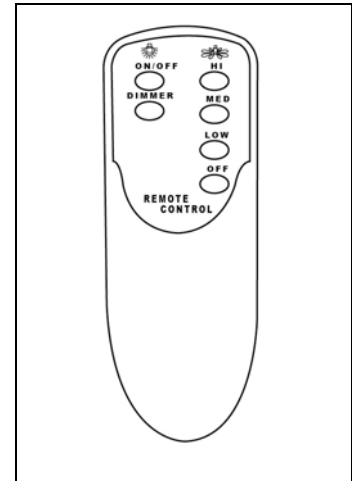

Fan rotating direction switch

The switch on the fan housing controls the direction of rotation. This changes the direction of air movement:

- In cold weather: Push the switch "UP" so that the fan will circulate the warm air trapped near the ceiling to move downwards throughout the room.
- In hot weather: Push switch "DOWN" so that the fan will create a breeze and circulate the air to the room.

CLEANING

Risk of injury: Before cleaning the fan, always switch off the power at the main circuit breaker and wait until the fan has come to a complete stop.

Clean the fan with a dry or damp soft cloth. Do not use any liquids or detergents.

DISPOSAL

Disposal of the fan: You are required to dispose of electric and electronic appliances separately from your household waste. Please inquire at your municipality regarding proper ways of disposal.

By separately disposing of your electric and electronic appliances, you are participating in recycling and you are helping to prevent potentially toxic substances from polluting the environment.

Disposal of the packaging: The packaging consists of cardboard and marked plastic and Styrofoam which can be recycled. Please recycle.

MALFUNCTIONS – TROUBLE SHOOTING

Risk of injury: Inappropriate repairs can lead to the fan not functioning safely. This can cause a hazard for yourself and your environment.

Most malfunctions are caused by small errors which you can easily resolve by yourself. Please check the following table before contacting your retailer. This way, you can spare yourself a lot of effort and cost.

Malfunction	Underlying cause (error)	Solution
Fan does not turn.	Fan switched off?	Switch on fan.
	No mains voltage?	Check circuit breaker.
	Batteries of remote control empty?	Install new batteries.
Fan vibrates.	Fan not installed properly?	Install fan thoroughly according to installation instructions.
Light does not work.	Lamp defective?	Exchange lamp.

If you can not resolve the malfunction yourself, please ask your retailer directly.

Please note that the warranty will be voided by inappropriate repairs.

TECHNICAL DATA

Speed	Voltage	Power	RPM
HI	230V ~ / 50Hz	45W	260
MED		29W	220
LOW		18W	150

MANUFACTURER

Vaxcel International Co., Ltd.

121 E North Avenue, Carol Stream, IL, USA

www.vaxcel.com